

REV	DATE	CHANGE	TR NO.	REV BY.

4

J4 HAND SWITCHES  
 J3 TEMPERATURE PROBE  
 J2 SOLENOID

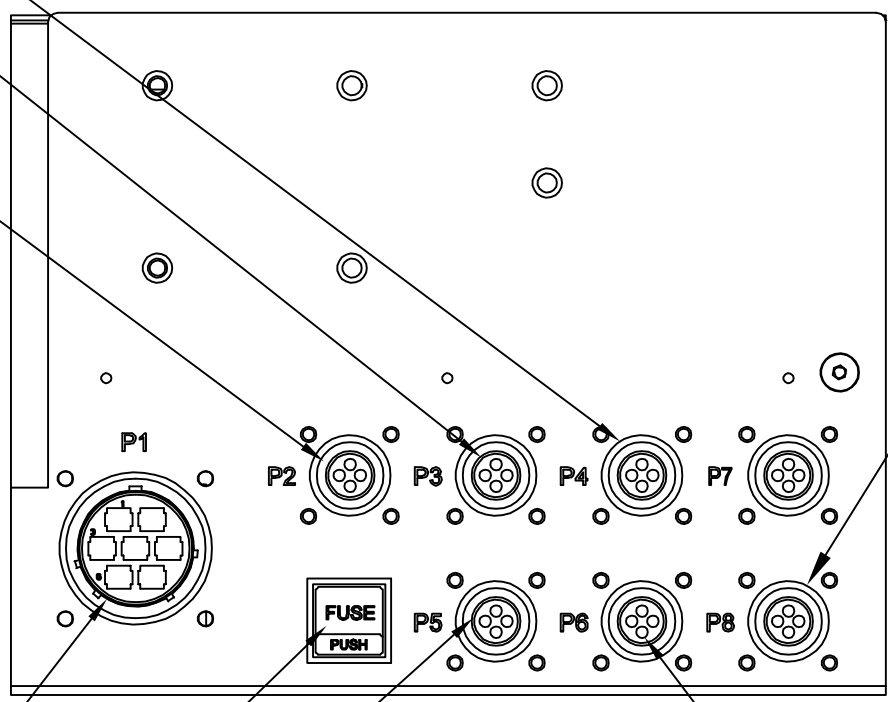

SOLID STATE RELAY OUTPUT

3

J1 POWER AND HEATER  
 FUSE 2 AMP  
 J5 PINCH POINT LS

J6 120 VAC OUTPUT

ON MACHINE  
 120 VAC  
 OPERATION

2

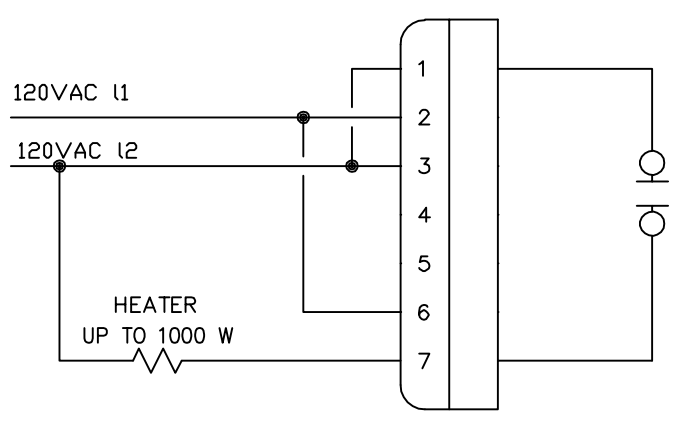
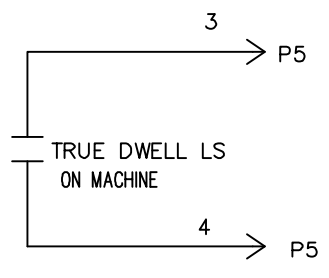
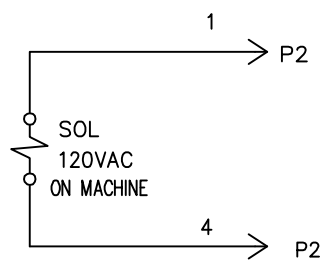

1

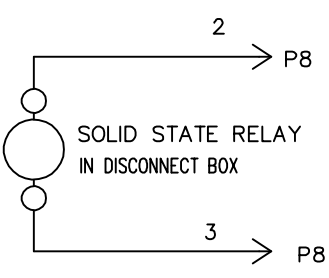
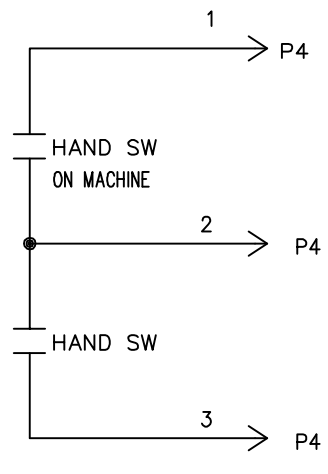
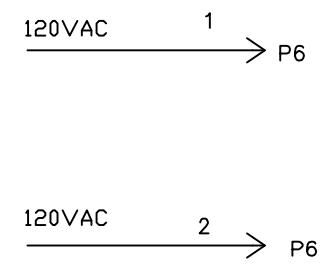
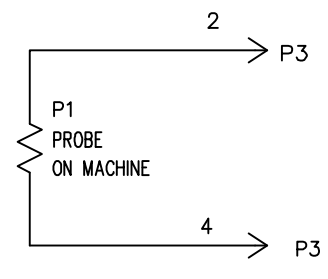

**AFM ENGINEERING, INC.**

1313 E. Borchard Ave  
 Santa Ana, CA 92705

TITLE AFM Engineering, Inc  
 Digital Control Box Back No PLC 120vac

DRAWING NO. Box\_Back\_With\_Cables.dwg SHEET 1 OF 1

DESIGNED BY IRWIN  
 DRAWN BY IRWIN  
 CHECKED BY C.S.I.  
 APPROVED BY C.S.I.